

_____ 'S

Travel journal

Car coupons

Instructions:

1. Cut out each of the coupons below and place them in a plastic or paper bag.
2. Keep the bag in the binder and allow your kids to trade them in for snacks, treats or small toys.

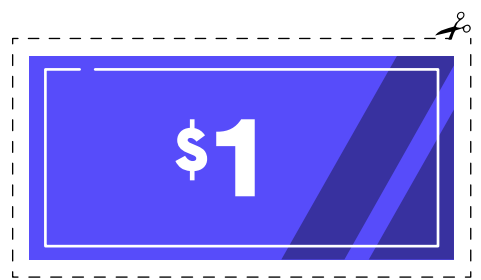

Tic-tac-toe

Instructions:

1. Challenge someone to a game of tic-tac-toe.
2. After you finish all of the games, add up the scores to see who wins!

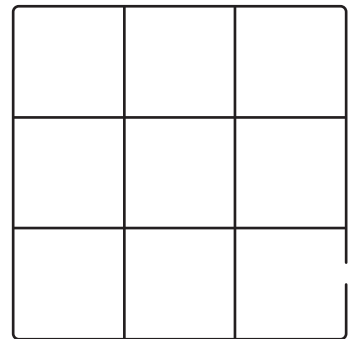
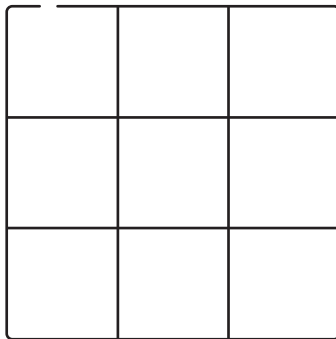
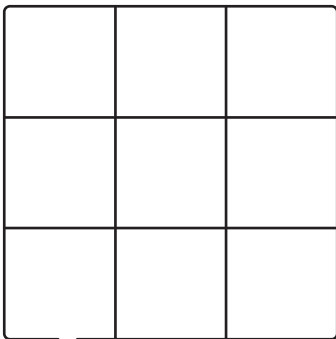
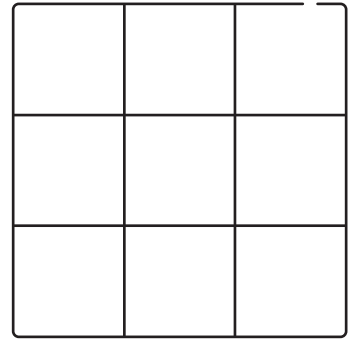
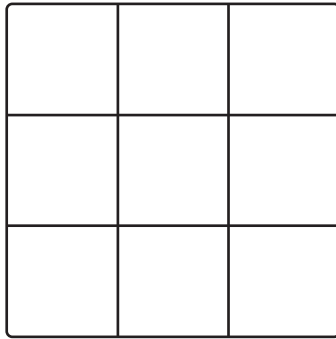
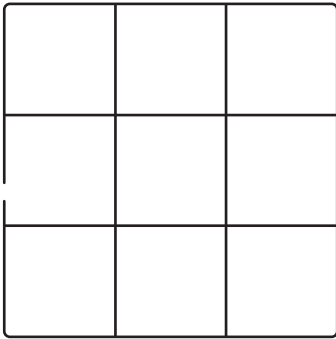
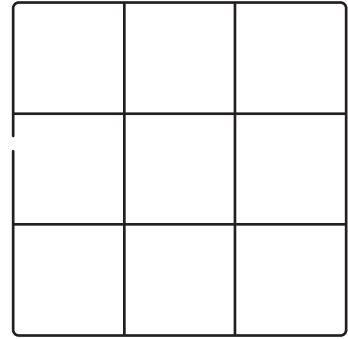
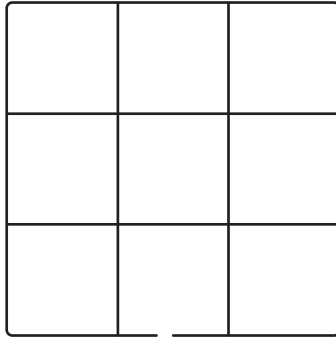
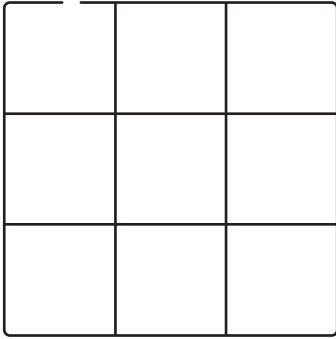

Player 1 score:

Player 2 score:

My travels

Instructions:

Color in each state that you've visited and try to fill out the entire map.

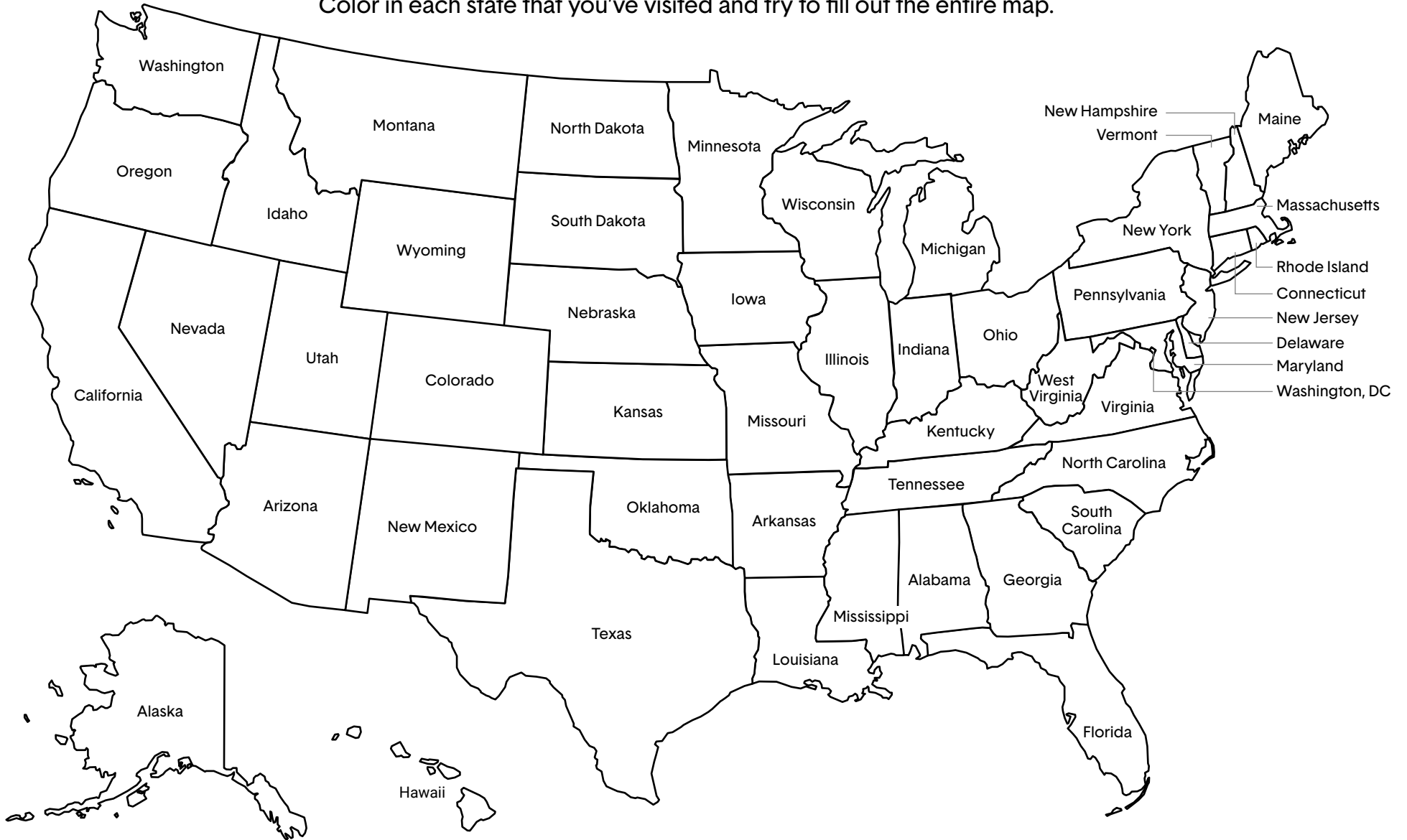

Build the car

Instructions:

1. Cut out each of the puzzle pieces.
2. Place them in a plastic or paper bag and place them in the travel binder.
3. Have your child put all of the pieces together using the template page.

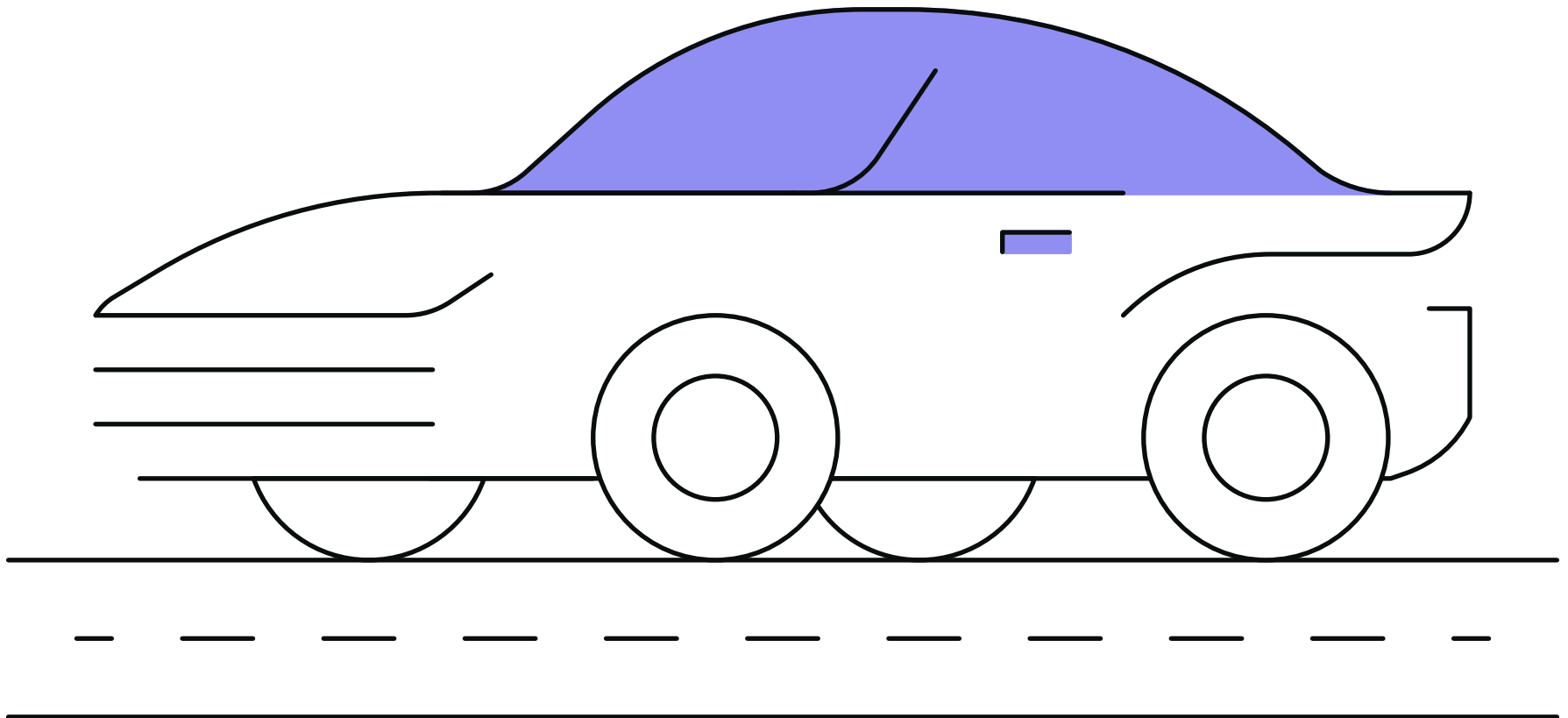

Puzzle pieces

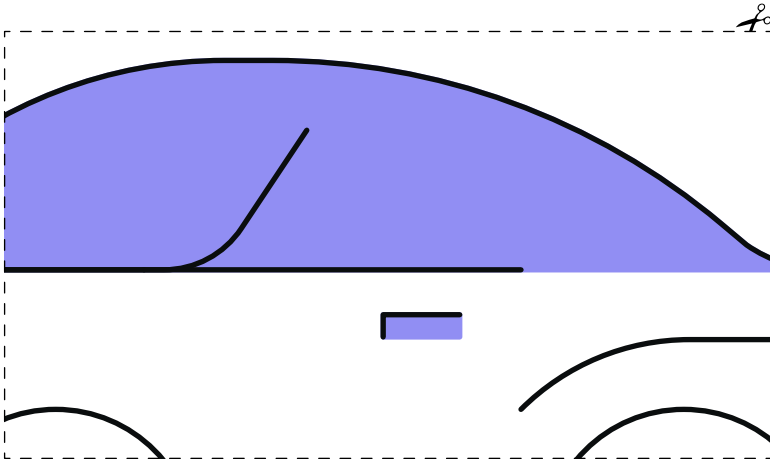
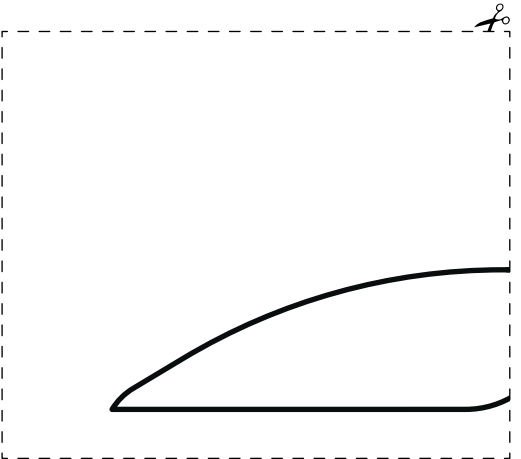
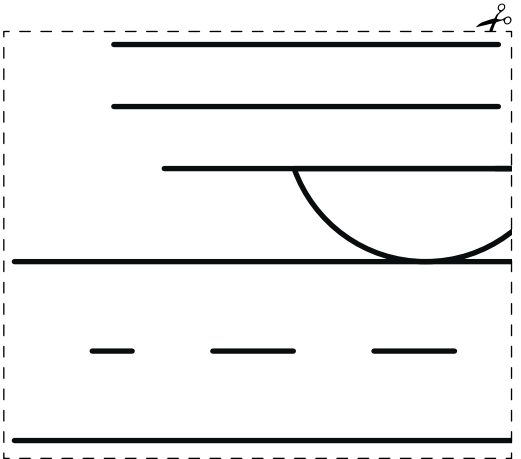
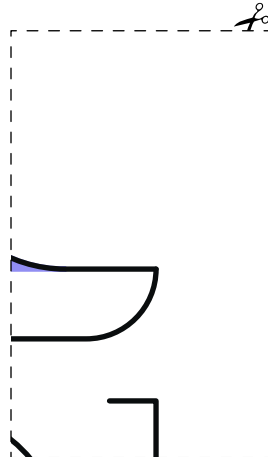
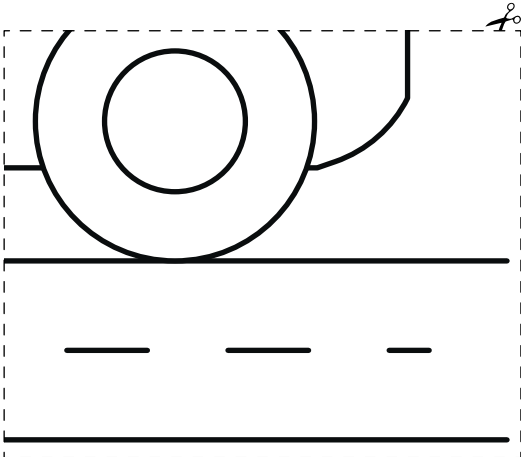
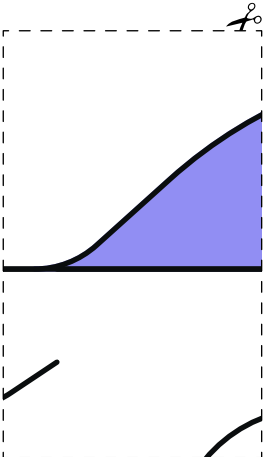
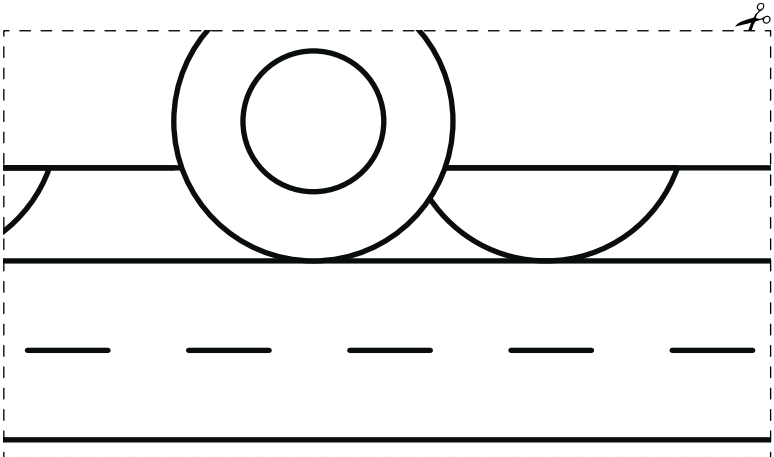

Car scavenger hunt

Instructions:

1. Look outside your window and search for the items below.
2. Mark them off as you find them.

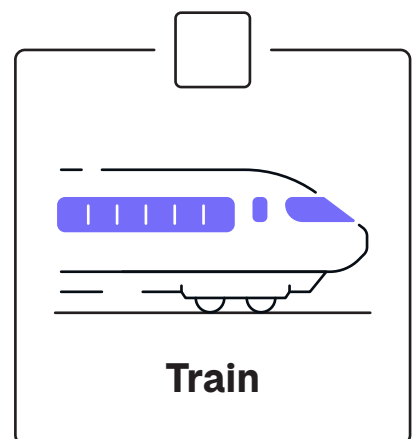
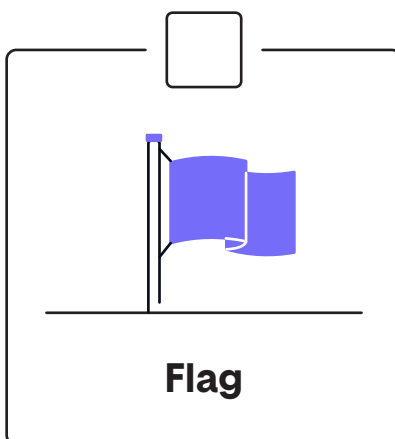
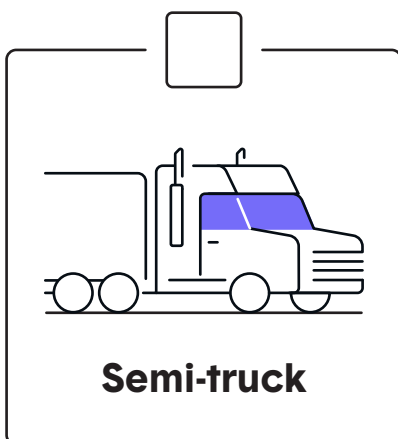
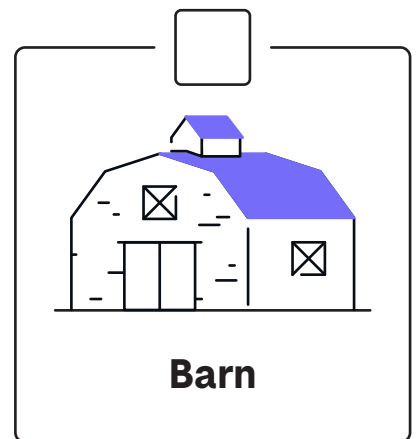
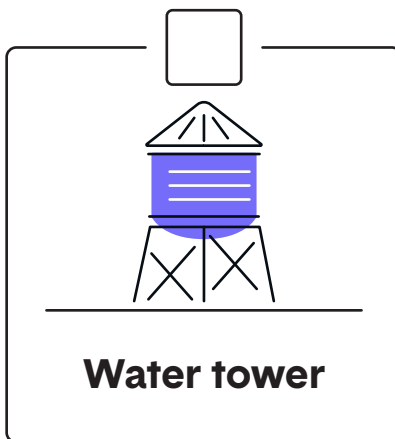
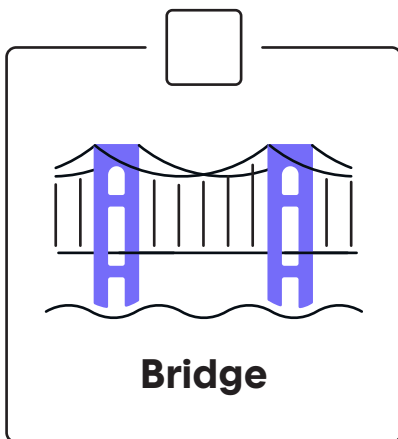
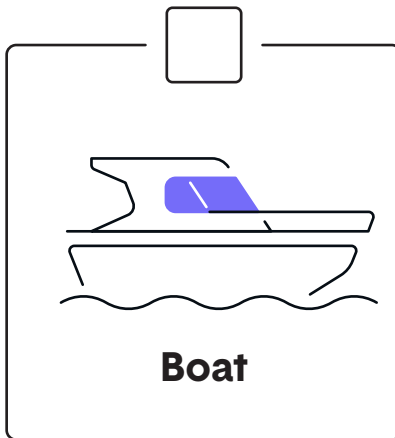
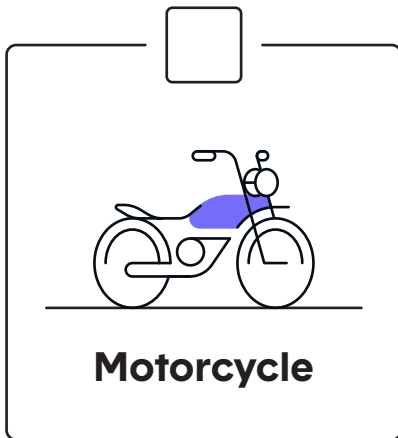

My travel journal

We are leaving from:

We are going to:



**Draw what you
are traveling in:**

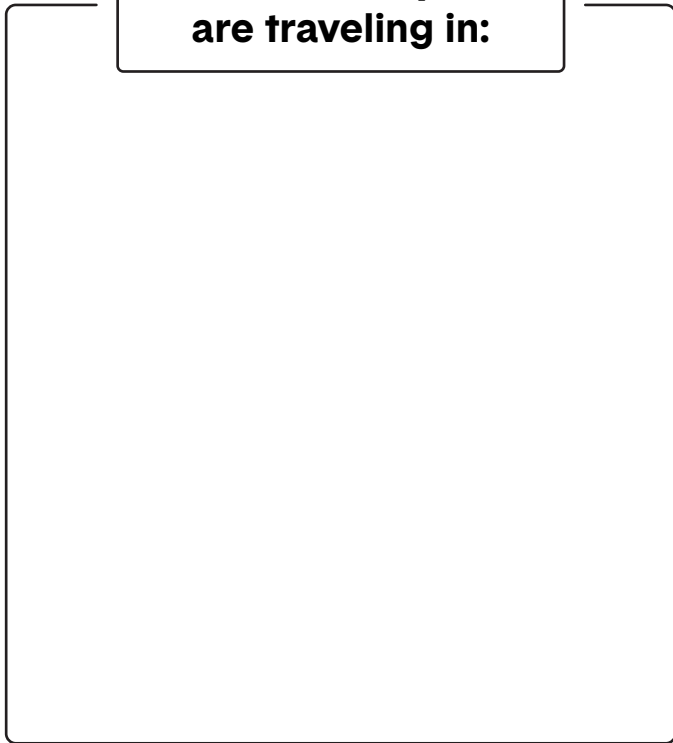

**Draw what the
weather is like:**

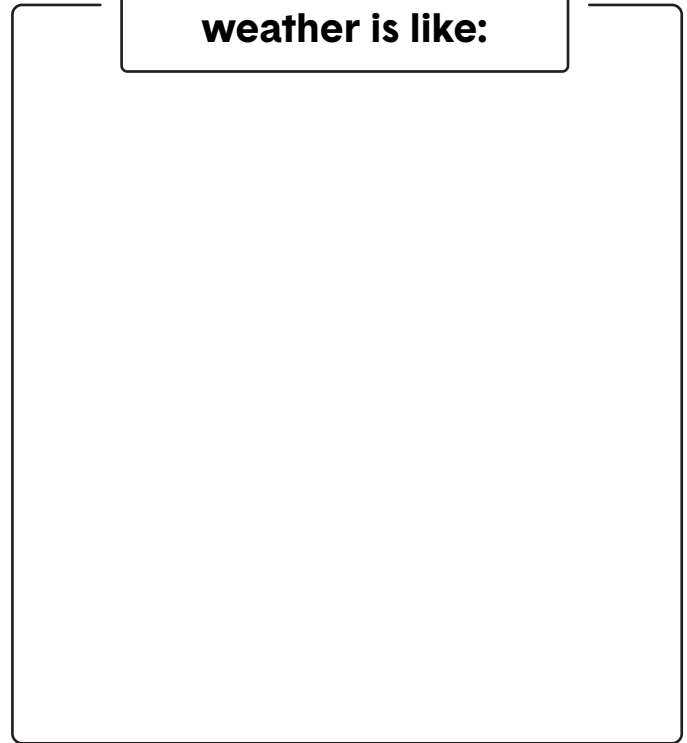

**My favorite part
of the trip was:**



**Where I want
to go next:**
